

Welded Steel Chains

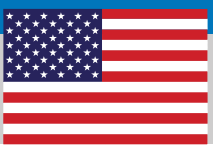

WELDED STEEL CONVEYOR CHAINS

Cobalt Chains welded steel chains are high-strength, rollerless chains that are often used in the lumber industry, grain conveying, or anywhere that bulk material conveyance is required. Premium, heat-treated sidebars are precision machined and welded to solid, tubular barrels, then connected with induction-hardened pins for maximum strength and durability. Our chains are built to exceed industry standards. Most common sizes are available from on-hand inventory and can be provided with welded attachments and paddles as a turn-key solution to meet your specific material handling needs.

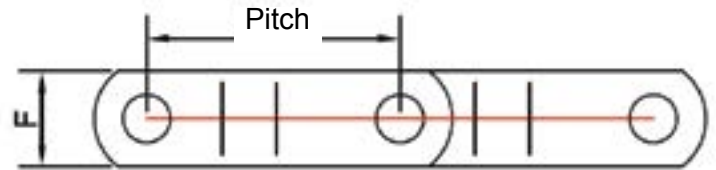
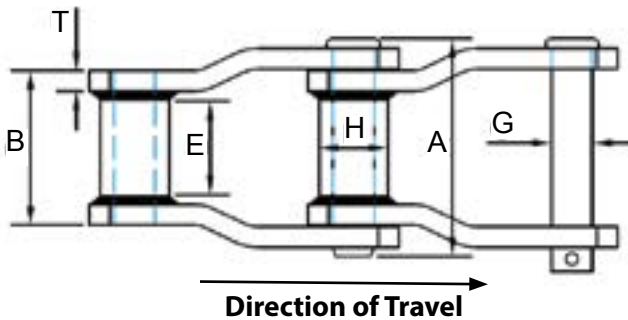

Standard WH Series																						
Chain	Pitch		A		E		Sidebars				Pins		Barrel				Minimum Ultimate Strength		Working Load		Weight	
							T		F		G		B		H							
	in	mm	in	mm	in	mm	in	mm	in	mm	in	mm	in	mm	in	mm	in	mm	lbs	kg	lbs	kg
WH78	2.609	66.30	3.00	78.20	1.00	25.40	0.25	6.35	1.25	31.75	0.50	12.70	2.00	50.80	0.88	22.22	33,000	15,000	3,000	1,350	4.10	
WH82	3.075	78.10	3.31	84.14	1.38	34.93	0.25	6.35	1.25	31.75	0.56	14.29	2.25	57.15	1.06	27.00	36,000	16,400	4,400	1,996	4.70	
WH124	4.000	101.60	4.25	107.95	1.50	38.10	0.38	9.52	1.50	38.10	0.75	19.05	2.81	74.43	1.25	31.75	57,000	26,000	7,350	3,334	8.00	
WH111	4.760	120.90	4.94	104.78	1.88	47.63	0.38	9.52	1.50	38.10	0.75	19.05	4.81	122.23	1.25	31.75	60,000	27,000	8,850	3,788	8.60	
WH106	6.000	152.40	4.25	107.95	1.50	38.10	0.38	9.52	1.50	38.10	0.75	19.05	2.81	71.43	1.25	31.75	60,000	27,000	7,350	3,334	7.00	
WH132	6.050	153.70	6.25	158.75	2.88	73.03	0.50	12.70	2.00	50.80	1.00	25.40	4.42	112.32	1.75	44.45	122,000	55,400	15,000	6,800	13.50	
WH150	6.050	153.70	6.25	158.75	2.88	73.03	0.50	12.70	2.50	63.50	1.00	25.40	4.42	112.32	1.75	44.45	122,000	55,400	15,000	6,800	16.80	
WH155	6.050	153.70	6.50	165.90	2.88	73.03	0.63	15.88	2.50	63.50	1.13	28.58	4.63	117.48	1.75	44.45	151,000	68,600	18,200	8,270	19.50	
WH157	6.050	153.70	6.75	171.45	2.75	69.85	0.63	15.88	2.50	63.50	1.13	28.58	4.63	117.48	1.75	44.45	175,000	79,379	29,000	13,154	20.00	
WH159	6.125	155.58	6.75	171.45	2.75	69.85	0.63	15.88	3.00	76.20	1.25	31.75	4.63	117.48	1.90	48.26	210,000	95,254	32,000	14,514	26.00	
WH200	6.125	155.58	6.75	171.45	2.75	69.85	0.63	15.88	2.50	63.50	1.25	31.75	4.63	117.48	1.90	48.26	190,000	86,183	32,000	14,514	22.10	



STAINLESS STEEL WELDED STEEL CONVEYOR CHAINS

- Side bars - AISI 316 Stainless Steel
- Hardened 17-4PH Pins & Bushings
- Standard & custom attachments

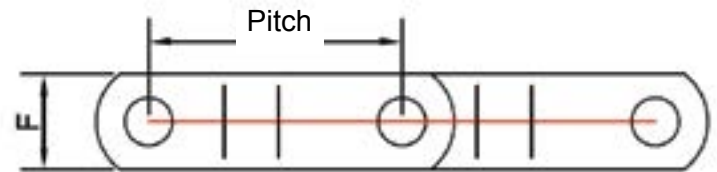
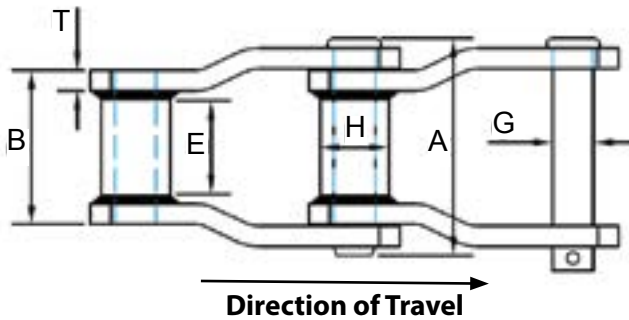

WS Stainless Steel Series																						
Chain	Pitch		A		E		Sidebars				Pins		Barrel				Minimum Ultimate Strength		Working Load		Weight	
							T	F		G	B		H									
	in	mm	in	mm	in	mm	in	mm	in	mm	in	mm	in	mm	in	mm	lbs	kg	lbs	kg	lbs/ft	
WS78	2.609	66.30	3.00	78.20	1.00	25.40	0.25	6.35	1.25	31.75	0.50	12.70	2.00	50.80	0.88	22.22	11,600	5,200	2,300	1,050	4.00	
WS82	3.075	78.10	3.31	84.14	1.38	34.93	0.25	6.35	1.25	31.75	0.56	14.29	2.25	57.15	1.06	27.00	13,000	5,900	2,600	1,200	4.80	
WS124	4.000	101.60	4.25	107.95	1.50	38.10	0.38	9.52	1.50	38.10	0.75	19.05	2.81	74.43	1.25	31.75	21,400	9,700	4,250	1,900	8.30	
WS106	6.000	152.40	4.25	107.95	1.50	38.10	0.38	9.52	1.50	38.10	0.75	19.05	2.81	71.43	1.25	31.75	38,000	17,200	4,650	2,100	7.00	
WS132	6.050	153.70	6.25	158.75	2.88	73.03	0.50	12.70	2.00	50.80	1.00	25.40	4.42	112.32	1.75	44.45	38,000	17,200	4,650	2,100	14.20	
WS150	6.050	153.70	6.25	158.75	2.88	73.03	0.50	12.70	2.50	63.50	1.00	25.40	4.42	112.32	1.75	44.45	56,400	25,600	11,200	5,100	16.80	
WS155	6.050	153.70	6.50	165.90	2.88	73.03	0.63	15.88	2.50	63.50	1.13	28.58	4.63	117.48	1.75	44.45	52,100	23,600	10,400	4,700	20.00	





HD WELDED STEEL DRAG CHAINS

- Cobalt Chains welded steel drag chains can be considered in place of S Series Cast Drag Chains
- Ideal in conditions of high abrasion and heat
- Hard face welding on all sliding surfaces is standard

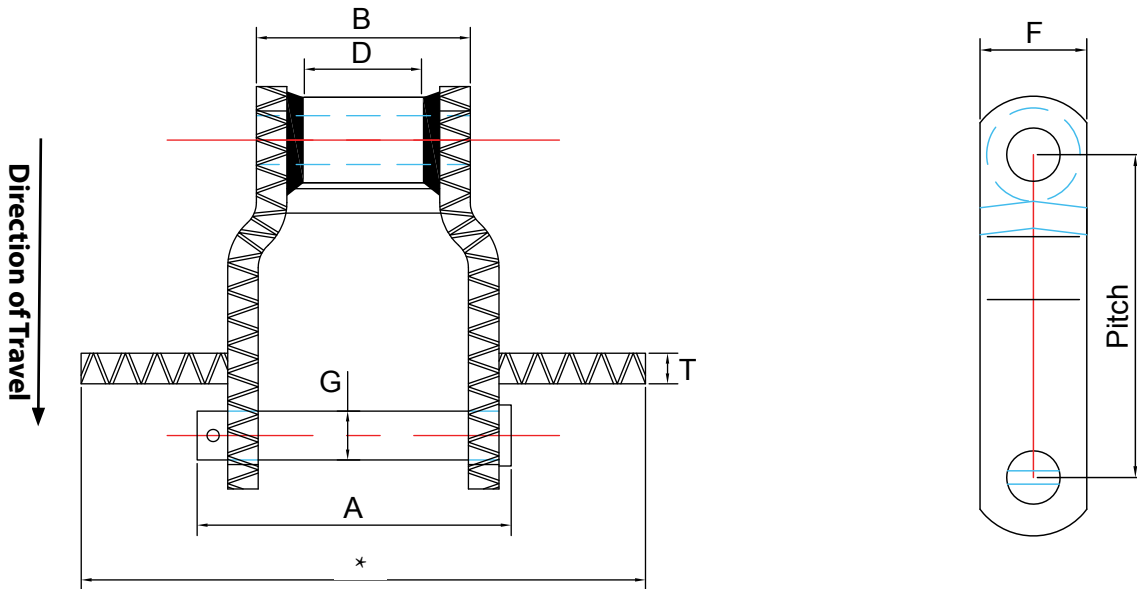

Heavy Duty Welded Steel Drag Chain (WHX)

Chain	Average Pitch		Width		Length of Bearing		Sidebar Thickness		Sidebar Height		Pin Dia		Gearing Width		Rated Working Load		Minimum Ultimate Strength		Weight	
			A	B	T	F	G	D												
	in	mm	in	mm	in	mm	in	mm	in	mm	in	mm	in	mm	lbs	kg	lbs	kg	lb/ft	kg/mtr
CWHX 5157	6.050	153.67	6.94	176.21	4.63	117.60	0.63	15.88	2.50	63.50	1.13	28.58	2.75	69.85	18,200	8,270	117,000	53,180	25.31	37.46
CWHX 5121**	9.000	228.60	9.75	247.65	6.31	160.27	1.13	28.58	2.50	63.50	1.25	31.75	3.63	92.09	27,600	12,550	205,000	93,180	40.47	60.70
CWHX 6121	9.000	228.60	9.75	247.65	6.31	160.27	1.13	28.58	2.50	63.50	1.25	31.75	3.63	92.09	27,600	12,550	205,000	93,180	40.47	60.70
CWHX 6067	9.000	228.60	8.50	215.90	5.50	139.70	0.75	19.05	2.50	63.50	1.25	31.75	3.63	92.09	24,300	11,045	195,000	86,640	30.43	44.65

* Flight width made to order

** CWHX 5121 and CWHX 6121 are dimensionally the same, except CWHX5121 runs closed end forward

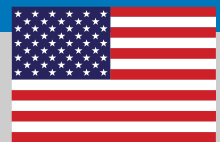

WELDED STEEL DRAG CHAINS

- Side bars - heat treated carbon steel
- Pins & bushes through hardened
- Standard & custom attachments



WH132 Log Hauler Chain

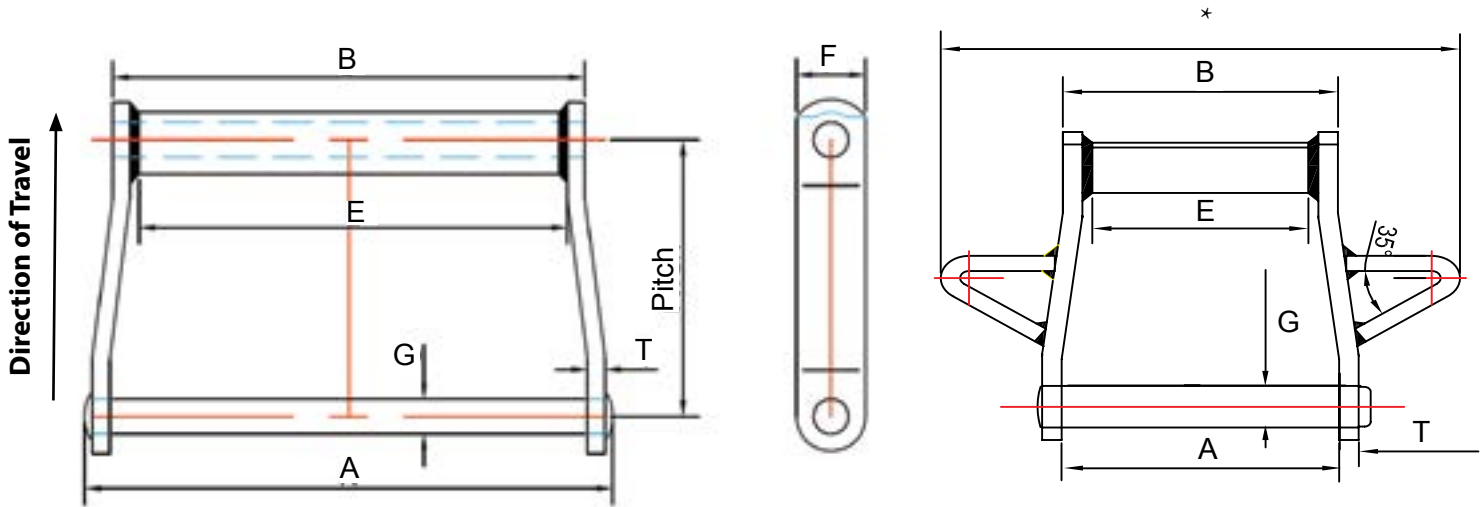

WDH Series

Chain	Pitch		A		E		Sidebars				Pins		B		Minimum Ultimate Strength		Working Load		Weight
							T		F		G								
	in	mm	in	mm	in	mm	in	mm	in	mm	in	mm	in	mm	lbs	kg	lbs	kg	lbs/ft
CWDH102	5.000	127.00	9.25	234.95	6.38	161.92	0.38	9.50	1.50	38.10	0.75	19.05	7.75	196.90	60,000	27,300	10,000	45,500	11.80
CWDH104	6.000	152.40	6.88	174.63	4.13	104.80	0.38	9.50	1.50	38.10	0.75	19.05	5.38	136.52	60,000	27,300	10,000	45,500	8.50
CWDH110	6.000	152.40	11.88	301.63	9.00	228.60	0.38	9.50	1.50	38.10	0.75	19.05	10.38	263.50	51,000	23,200	8,500	38,000	12.00
CWDH112	8.000	203.20	11.88	301.63	9.00	228.60	0.38	9.50	1.50	38.10	0.75	19.05	10.38	263.50	60,000	23,200	10,000	45,500	10.00
CWDH116	8.006	203.20	15.38	390.52	12.75	323.85	0.38	9.50	1.75	44.45	0.75	19.05	14.13	358.80	69,000	31,500	11,500	52,501	8.50
CWDH120	6.000	152.40	12.13	307.98	8.75	222.25	0.50	12.70	2.00	50.80	0.88	22.22	10.25	260.35	90,000	40,900	15,000	6,800	20.00
CWDH480	8.000	203.20	14.63	371.48	11.19	284.16	0.50	12.70	2.00	50.80	0.88	22.22	12.75	323.85	90,000	40,900	15,000	6,800	18.00
CWDH580	8.000	203.20	14.63	371.48	11.19	284.16	0.50	12.70	2.00	50.80	1.00	25.40	12.75	323.85	123,000	55,900	20,500	9,300	19.40

* Wing width made to order



WELDED STEEL ATTACHMENTS

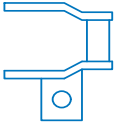

A1

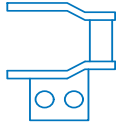

A2

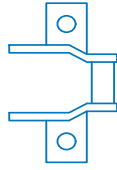

K1

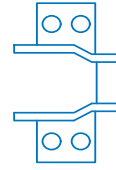

K2

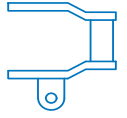

A22

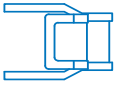

H1

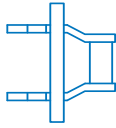

RF2

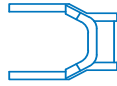

H2

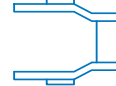

RR

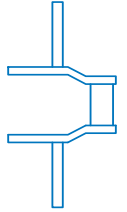

Bar Flight

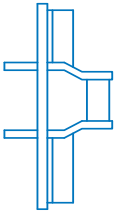
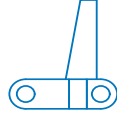
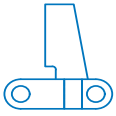

UHMW with Angle Backer

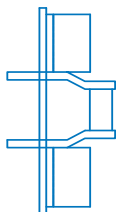

UHMW with V-cup Flight

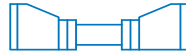

Cradle

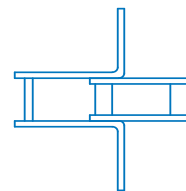

L2

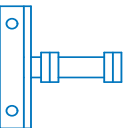

G2

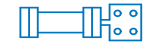
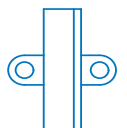

G4

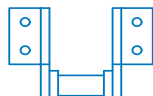

F2

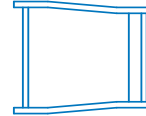

C1, C3 & C4

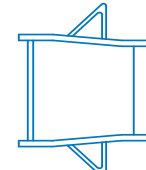

Wing

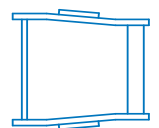

A22

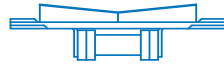
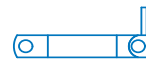

E. Cradle

